







Lubricators MS-LOE, MS series

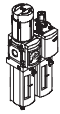
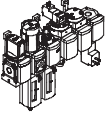

# Lubricators MS-LOE, MS series

Product range overview – MS series service units



Type	Size	Pneumatic connection in housing	Connecting plate	Pressure regulation range [bar]						Grade of filtration [µm]				
				0.05	0.05	0.1	0.3	0.1	0.5					
				... 0.7	... 2.5	... 4	... 7	... 12	... 16	0.01	1	5	40	
Code			AG...	D2	D4	D5	D6	D7	D8	A	B	C	E	
<b>Service units</b>														
<b>MSB-FRC</b> 	4	G1/8, G1/4	G1/8, G1/4, G3/8	-	-	-	■	■	-	-	-	■	■	
	6	G1/4, G3/8, G1/2	G1/4, G3/8, G1/2, G3/4	-	-	-	■	■	-	-	-	■	■	
	9	-												
	12	-												
<b>Service unit combinations (further variants can be ordered using the configurator → Internet: msb4, msb6 or msb9)</b>														
<b>MSB</b> 	4	G1/4	G1/8, G1/4, G3/8	-	-	-	■	■	-	-	-	■	■	
	6	G1/2	G1/4, G3/8, G1/2, G3/4	-	-	-	■	■	-	-	-	■	■	
	9	-												
	12	-												
<b>Individual devices</b>														
<b>Filter regulators MS-LFR</b> 	4	G1/8, G1/4	G1/8, G1/4, G3/8	-	-	■	■	■	-	-	-	■	■	
	6	G1/4, G3/8, G1/2	G1/4, G3/8, G1/2, G3/4	-	-	■	■	■	■	-	-	■	■	
	9	-												
	12	-	G1, G1 1/4, G1 1/2, G2	-	-	-	■	■	■	-	-	■	■	
<b>Filters MS-LF</b> 	4	G1/8, G1/4	G1/8, G1/4, G3/8	-	-	-	-	-	-	-	-	■	■	
	6	G1/4, G3/8, G1/2	G1/4, G3/8, G1/2, G3/4	-	-	-	-	-	-	-	-	■	■	
	9	-												
	12	-	G1, G1 1/4, G1 1/2, G2	-	-	-	-	-	-	-	-	■	■	
<b>Fine and micro filters MS-LFM</b> 	4	G1/8, G1/4	G1/8, G1/4, G3/8	-	-	-	-	-	-	■	■	-	-	
	6	G1/4, G3/8, G1/2	G1/4, G3/8, G1/2, G3/4	-	-	-	-	-	-	■	■	-	-	
	9	G3/4, G1	G1/2, G3/4, G1, G1 1/4, G1 1/2	-	-	-	-	-	-	■	■	-	-	
	12	-	G1, G1 1/4, G1 1/2, G2	-	-	-	-	-	-	■	■	-	-	
<b>Activated carbon filters MS-LFX</b> 	4	G1/8, G1/4	G1/8, G1/4, G3/8	-	-	-	-	-	-	-	-	-	-	
	6	G1/4, G3/8, G1/2	G1/4, G3/8, G1/2, G3/4	-	-	-	-	-	-	-	-	-	-	
	9	G3/4, G1	G1/2, G3/4, G1, G1 1/4, G1 1/2	-	-	-	-	-	-	-	-	-	-	
	12	-	G1, G1 1/4, G1 1/2, G2	-	-	-	-	-	-	-	-	-	-	
<b>Water separators MS-LWS</b> 	4	-												
	6	G1/4, G3/8, G1/2	G1/4, G3/8, G1/2, G3/4	-	-	-	-	-	-	-	-	-	-	
	9	-												
	12	-												

# Lubricators MS-LOE, MS series

Product range overview – MS series service units

Type	Size	Bowl guard		Condensate drains				Pressure indicator					Actuator lock		Options		→ Page/ Internet
		Plastic bowl with plastic bowl guard	Metal bowl	Manual rotary	Semi-automatic	Fully automatic	External, fully automatic, electrical	Cover plate (without pressure gauge)	Integrated MS pressure gauge	Adapter plate for EN pressure gauge G1/8	Adapter plate for EN pressure gauge G1/4	Pressure sensor	Rotary knob, lockable	Rotary knob, long	Silencer	Flow direction from right to left	
Code		R	U	M	H	V	E...	VS	AG	A8	A4	AD...	AS	LD	S	Z	
<b>Service units</b>																	
MSB-FRC	4	■	-	■	-	■	-	-	■	-	-	-	■	-	-	■	msb4
	6	■	■	■	-	■	-	-	■	-	-	-	■	-	-	■	msb6
	9	-	-	-	-	-	-	-	-	-	-	-	-	-	-	-	-
	12	-	-	-	-	-	-	-	-	-	-	-	-	-	-	-	-
<b>Service unit combinations</b>																	
MSB	4	■	■	■	-	■	-	-	■	-	-	-	■	-	-	■	msb4
	6	■	■	■	-	■	-	-	■	-	-	-	■	-	-	■	msb6
	9	-	-	-	-	-	-	-	-	-	-	-	-	-	-	-	-
	12	-	-	-	-	-	-	-	-	-	-	-	-	-	-	-	-
<b>Individual devices</b>																	
Filter regulators MS-LFR	4	■	■	■	■	■	-	■	■	■	■	■	■	■	-	■	ms4-lfr
	6	■	■	■	■	■	■	■	■	-	■	■	■	■	-	■	ms6-lfr
	9	-	-	-	-	-	-	-	-	-	-	-	-	-	-	-	-
	12	-	■	■	-	■	■	■	■	-	■	-	■	■	-	■	ms12-lfr
Filters MS-LF	4	■	■	■	■	■	-	-	-	-	-	-	-	-	-	■	ms4-lf
	6	■	■	■	■	■	■	-	-	-	-	-	-	-	-	■	ms6-lf
	9	-	-	-	-	-	-	-	-	-	-	-	-	-	-	-	-
	12	-	■	■	-	■	■	-	-	-	-	-	-	-	-	■	ms12-lf
Fine and micro filters MS-LFM	4	■	■	■	■	■	-	-	-	-	-	-	-	-	-	■	ms4-lfm
	6	■	■	■	■	■	■	-	-	-	-	-	-	-	-	■	ms6-lfm
	9	-	■	■	-	■	■	-	-	-	-	-	-	-	-	■	ms9-lfm
	12	-	■	■	-	■	■	-	-	-	-	-	-	-	-	■	ms12-lfm
Activated carbon filters MS-LFX	4	■	■	-	-	-	-	-	-	-	-	-	-	-	-	■	ms4-lfx
	6	■	■	-	-	-	-	-	-	-	-	-	-	-	-	■	ms6-lfx
	9	-	■	-	-	-	-	-	-	-	-	-	-	-	-	■	ms9-lfx
	12	-	■	-	-	-	-	-	-	-	-	-	-	-	-	■	ms12-lfx
Water separators MS-LWS	4	-	-	-	-	-	-	-	-	-	-	-	-	-	-	-	-
	6	-	■	-	-	■	■	-	-	-	-	-	-	-	-	■	ms6-lws
	9	-	-	-	-	-	-	-	-	-	-	-	-	-	-	-	-
	12	-	-	-	-	-	-	-	-	-	-	-	-	-	-	-	-

# Lubricators MS-LOE, MS series

Product range overview – MS series service units



Type	Size	Pneumatic connection in housing	Connecting plate	Pressure regulation range [bar]						Supply voltage			
				0.05 ... 0.7	0.05 ... 2.5	0.1 ... 4	0.3 ... 7	0.1 ... 12	0.5 ... 16	24 V DC, connection pattern to EN 175301	24 V DC, connection pattern M12 to DESINA	110 V AC, connection pattern to EN 175301	230 V AC, connection pattern to EN 175301
Code			AG...	D2	D4	D5	D6	D7	D8	V24	V24P	V110	V230
<b>Individual devices</b>													
Pressure regulators <b>MS-LR</b>		4	G1/8, G1/4	G1/8, G1/4, G3/8	-	-	■	■	■	-	-	-	-
		6	G1/4, G3/8, G1/2	G1/4, G3/8, G1/2, G3/4	-	-	■	■	■	■	-	-	-
		9	-										
		12	-	G1, G1 1/4, G1 1/2, G2	-	-	-	■	■	■	-	-	-
Pressure regulators <b>MS-LRB</b>		4	G1/4	G1/8, G1/4, G3/8	-	-	■	■	■	-	-	-	-
		6	G1/2	G1/4, G3/8, G1/2, G3/4	-	-	■	■	■	■	-	-	-
		9	-										
		12	-										
Precision pressure regulators <b>MS-LRP</b>		4	-										
		6	G1/4, G3/8, G1/2	G1/4, G3/8, G1/2, G3/4	■	■	■	-	■	-	-	-	-
		9	-										
		12	-										
Precision pressure regulators <b>MS-LRPB</b>		4	-										
		6	G1/2	G1/4, G3/8, G1/2, G3/4	■	■	■	-	■	-	-	-	-
		9	-										
		12	-										
Electrical pressure regulators <b>MS-LRE</b>		4	-										
		6	G1/4, G3/8, G1/2	G1/4, G3/8, G1/2, G3/4	-	-	■	■	■	■	-	-	-
		9	-										
		12	-										
Lubricators <b>MS-LOE</b>		4	G1/8, G1/4	G1/8, G1/4, G3/8	-	-	-	-	-	-	-	-	-
		6	G1/4, G3/8, G1/2	G1/4, G3/8, G1/2, G3/4	-	-	-	-	-	-	-	-	-
		9	-										
		12	-	G1, G1 1/4, G1 1/2, G2	-	-	-	-	-	-	-	-	-
Electrical on-off valves <b>MS-EM(1)</b>		4	G1/8, G1/4	G1/8, G1/4, G3/8	-	-	-	-	-	-	-	-	-
		6	G1/4, G3/8, G1/2	G1/4, G3/8, G1/2, G3/4	-	-	-	-	-	-	-	-	-
		9	-										
		12	-	G1, G1 1/4, G1 1/2, G2	-	-	-	-	-	-	-	-	-
Electrical on-off valves <b>MS-EE</b>		4	G1/8, G1/4	G1/8, G1/4, G3/8	-	-	-	-	-	-	■	-	■
		6	G1/4, G3/8, G1/2	G1/4, G3/8, G1/2, G3/4	-	-	-	-	-	-	■	-	■
		9	-										
		12	-	G1, G1 1/4, G1 1/2, G2	-	-	-	-	-	-	■	■	■
Electrical soft-start valves <b>MS-DL</b>		4	G1/8, G1/4	G1/8, G1/4, G3/8	-	-	-	-	-	-	-	-	-
		6	G1/4, G3/8, G1/2	G1/4, G3/8, G1/2, G3/4	-	-	-	-	-	-	-	-	-
		9	-										
		12	-	G1, G1 1/4, G1 1/2, G2	-	-	-	-	-	-	-	-	-
Electrical soft-start valves <b>MS-DE</b>		4	G1/8, G1/4	G1/8, G1/4, G3/8	-	-	-	-	-	-	■	-	■
		6	G1/4, G3/8, G1/2	G1/4, G3/8, G1/2, G3/4	-	-	-	-	-	-	■	-	■
		9	-										
		12	-	G1, G1 1/4, G1 1/2, G2	-	-	-	-	-	-	■	■	■
Soft start and exhaust valves <b>MS-SV</b>		4	-										
		6	G1/2	G1/4, G3/8, G1/2, G3/4	-	-	-	-	-	-	■	-	-
		9	-										
		12	-										

# Lubricators MS-LOE, MS series

Product range overview – MS series service units







Type	Size	Bowl guard		Pressure indicator				Actuator lock		Options		→ Page/ Internet	
		Plastic bowl with plastic bowl guard	Metal bowl	Cover plate (without pressure gauge)	Integrated MS pressure gauge	Adapter plate for EN pressure gauge G1/8	Adapter plate for EN pressure gauge G1/4	Pressure sensor	Rotary knob, lockable	Rotary knob, long	Silencer		Flow direction from right to left
Code		R	U	VS	AG	A8	A4	AD...	AS	LD	S	Z	
<b>Individual devices</b>													
Pressure regulators <b>MS-LR</b>	4	-	-	■	■	■	■	■	■	■	-	■	ms4-lr
	6	-	-	■	■	-	■	■	■	■	-	■	ms6-lr
	9	-	-	-	-	-	-	-	-	-	-	-	-
	12	-	-	■	■	-	■	-	■	■	-	■	ms12-lr
Pressure regulators <b>MS-LRB</b>	4	-	-	■	■	■	■	■	■	■	-	■	ms4-lrb
	6	-	-	■	■	-	■	■	■	■	-	■	ms6-lrb
	9	-	-	-	-	-	-	-	-	-	-	-	-
	12	-	-	-	-	-	-	-	-	-	-	-	-
Precision pressure regulators <b>MS-LRP</b>	4	-	-	-	-	-	-	-	-	-	-	-	-
	6	-	-	■	-	■	■	■	■	■	-	■	ms6-lrp
	9	-	-	-	-	-	-	-	-	-	-	-	-
	12	-	-	-	-	-	-	-	-	-	-	-	-
Precision pressure regulators <b>MS-LRPB</b>	4	-	-	-	-	-	-	-	-	-	-	-	-
	6	-	-	■	-	■	■	■	■	■	-	■	ms6-lrpb
	9	-	-	-	-	-	-	-	-	-	-	-	-
	12	-	-	-	-	-	-	-	-	-	-	-	-
Electrical pressure regulators <b>MS-LRE</b>	4	-	-	-	-	-	-	-	-	-	-	-	-
	6	-	-	■	■	-	■	-	-	-	-	■	ms6-lre
	9	-	-	-	-	-	-	-	-	-	-	-	-
	12	-	-	-	-	-	-	-	-	-	-	-	-
Lubricators <b>MS-LOE</b>	4	■	■	-	-	-	-	-	-	-	-	■	8
	6	■	■	-	-	-	-	-	-	-	-	■	8
	9	-	-	-	-	-	-	-	-	-	-	-	-
	12	-	■	-	-	-	-	-	-	-	-	■	14
Electrical on-off valves <b>MS-EM(1)</b>	4	-	-	■	■	■	■	■	-	-	■	■	ms4-em1
	6	-	-	■	■	-	■	■	-	-	■	■	ms6-em1
	9	-	-	-	-	-	-	-	-	-	-	-	-
	12	-	-	■	■	-	■	-	-	-	■	■	ms12-em
Electrical on-off valves <b>MS-EE</b>	4	-	-	■	■	■	■	■	-	-	■	■	ms4-ee
	6	-	-	■	■	-	■	■	-	-	■	■	ms6-ee
	9	-	-	-	-	-	-	-	-	-	-	-	-
	12	-	-	■	■	-	■	-	-	-	■	■	ms12-ee
Electrical soft-start valves <b>MS-DL</b>	4	-	-	■	■	■	■	■	-	-	-	■	ms4-dl
	6	-	-	■	■	-	■	■	-	-	-	■	ms6-dl
	9	-	-	-	-	-	-	-	-	-	-	-	-
	12	-	-	■	■	-	■	-	-	-	-	■	ms12-dl
Electrical soft-start valves <b>MS-DE</b>	4	-	-	■	■	■	■	■	-	-	-	■	ms4-de
	6	-	-	■	■	-	■	■	-	-	-	■	ms6-de
	9	-	-	-	-	-	-	-	-	-	-	-	-
	12	-	-	■	■	-	■	-	-	-	-	■	ms12-de
Soft start and exhaust valves <b>MS-SV</b>	4	-	-	-	-	-	-	-	-	-	-	-	-
	6	-	-	■	■	-	■	■	-	-	■	■	ms6-sv
	9	-	-	-	-	-	-	-	-	-	-	-	-
	12	-	-	-	-	-	-	-	-	-	-	-	-

# Lubricators MS-LOE, MS series

Product range overview – MS series service units



Type	Size	Pneumatic connection in housing	Connecting plate	Pressure regulation range [bar]				Supply voltage				
				0.1 ... 4	0.3 ... 7	0.1 ... 12	0.5 ... 16	24 V DC, connection pattern to EN 175301	24 V DC, connection pattern M12 to DESINA	110 V AC, connection pattern to EN 175301	230 V AC, connection pattern to EN 175301	
Code			AG...	D5	D6	D7	D8	V24	V24P	V110	V230	
<b>Individual devices</b>												
Membrane air dryers <b>MS-LDM1</b>		4	G1/8, G1/4	G1/8, G1/4, G3/8	-	-	-	-	-	-	-	-
		6	G1/4, G3/8, G1/2	G1/4, G3/8, G1/2, G3/4	-	-	-	-	-	-	-	-
		9	-	-	-	-	-	-	-	-	-	-
		12	-	-	-	-	-	-	-	-	-	-
Branching modules <b>MS-FRM</b>		4	G1/8, G1/4	G1/8, G1/4, G3/8	-	-	-	-	-	-	-	-
		6	G1/4, G3/8, G1/2	G1/4, G3/8, G1/2, G3/4	-	-	-	-	-	-	-	-
		9	-	-	-	-	-	-	-	-	-	-
		12	-	G1, G1 1/4, G1 1/2, G2	-	-	-	-	-	-	-	-
Distributor blocks <b>MS-FRM-FRZ</b>		4	G1/4	-	-	-	-	-	-	-	-	-
		6	G1/2	-	-	-	-	-	-	-	-	-
		9	-	-	-	-	-	-	-	-	-	-
		12	-	-	-	-	-	-	-	-	-	-
Flow sensors <b>MS-SFE</b>		4	-	-	-	-	-	-	-	-	-	-
		6	G1/2	G1/2	-	-	-	-	-	-	-	-
		9	-	-	-	-	-	-	-	-	-	-
		12	-	-	-	-	-	-	-	-	-	-
Flow sensors <b>SFAM</b>		4	-	-	-	-	-	-	-	-	-	-
		6	G1/2	G1/2	-	-	-	-	-	-	-	-
		9	-	-	-	-	-	-	-	-	-	-
		12	-	-	-	-	-	-	-	-	-	-

# Lubricators MS-LOE, MS series

Product range overview – MS series service units



Type	Size	Bowl guard		Pressure indicator				Switch output		Options		→ Page/ Internet	
		Plastic bowl with plastic bowl guard	Metal bowl	Cover plate (without pressure gauge)	Integrated MS pressure gauge	Adapter plate for EN pressure gauge G1/8	Adapter plate for EN pressure gauge G1/4	Pressure sensor	2x PNP	2x NPN	Silencer		Flow direction from right to left
Code		R	U	VS	AG	A8	A4	AD...	P2/2S	N2/2S	S	Z/R	
<b>Individual devices</b>													
Membrane air dryers <b>MS-LDM1</b>	4	-	■	-	-	-	-	-	-	-	-	■	ms4-ldm1
	6	-	■	-	-	-	-	-	-	-	-	■	ms6-ldm1
	9	-	-	-	-	-	-	-	-	-	-	-	-
	12	-	-	-	-	-	-	-	-	-	-	-	-
Branching modules <b>MS-FRM</b>	4	-	-	■	■	■	■	■	-	-	-	■	ms4-frm
	6	-	-	■	■	-	■	■	-	-	-	■	ms6-frm
	9	-	-	-	-	-	-	-	-	-	-	-	-
	12	-	-	■	-	-	-	-	-	-	-	-	ms12-frm
Distributor blocks <b>MS-FRM-FRZ</b>	4	-	-	-	-	-	-	-	-	-	-	■	ms4-frm
	6	-	-	-	-	-	-	-	-	-	-	■	ms6-frm
	9	-	-	-	-	-	-	-	-	-	-	-	-
	12	-	-	-	-	-	-	-	-	-	-	-	-
Flow sensors <b>MS-SFE</b>	4	-	-	-	-	-	-	-	-	-	-	-	-
	6	-	-	-	-	-	-	-	■	■	-	■ <sup>1)</sup>	ms6-sfe
	9	-	-	-	-	-	-	-	-	-	-	-	-
	12	-	-	-	-	-	-	-	-	-	-	-	-
Flow sensors <b>SFAM</b>	4	-	-	-	-	-	-	-	-	-	-	-	-
	6	-	-	-	-	-	-	-	■	■	-	■	sfam
	9	-	-	-	-	-	-	-	-	-	-	-	-
	12	-	-	-	-	-	-	-	-	-	-	-	-

1) Can only be ordered using the configurator → Internet: ms6-sfe

# Lubricators MS4/MS6-LOE, MS series

Peripherals overview

FESTO

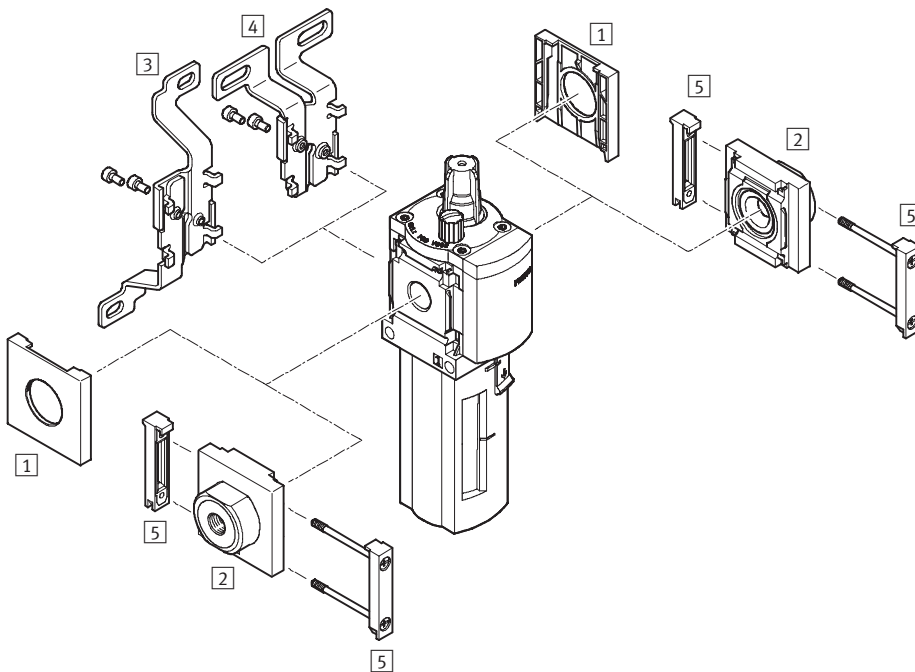

- - Note

Additional accessories:

- Module connector for combination with sizes MS4/MS6 or size MS9 → Internet: amv, rmv, armv
- Adapter plate for mounting on profiles → Internet: ipm-80, ipm-40-80, ipm-80-80

Mounting attachments and accessories						
		Individual unit		Combination		→ Page/Internet
		without connecting plate	with connecting plate	without connecting plate	with connecting plate	
1	Cover cap MS4/6-END	■	-	■	-	ms4-end, ms6-end
2	Connecting plate MS4/6-AG...	-	■	-	■	ms4-ag, ms6-ag
3	Mounting bracket MS4/6-WB	■	■	-	-	ms4-wb, ms6-wb
4	Mounting bracket MS4-WBM	■	■	-	-	ms4-wbm
5	Module connector MS4/6-MV	-	■	■	■	ms4-mv, ms6-mv
-	Mounting bracket MS4/6-WP/WPB/WPE/WPM	-	■	■	■	ms4-wp, ms6-wp



# Lubricators MS4/MS6-LOE, MS series

Type codes

MS 6 - LOE - 1/4 - U

**Series**

MS	Standard service unit
----	-----------------------

**Size**

4	Grid dimension 40 mm
6	Grid dimension 62 mm

**Service function**

LOE	Lubricators
-----	-------------

**Connection size**

<b>MS4</b>	
1/8	Thread G1/8
1/4	Thread G1/4
<b>MS6</b>	
1/4	Thread G1/4
3/8	Thread G3/8
1/2	Thread G1/2

**Bowl guard**

R	Plastic bowl guard
U	Metal bowl

Further variants can be ordered using the modular system → 13

- Connecting plates
- Type of mounting
- Alternative flow direction



# Lubricators MS4/MS6-LOE, MS series

Technical data

FESTO

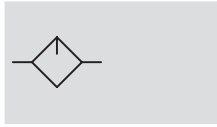
Function



-  - Flow rate  
1,100 ... 7,200 l/min
-  - Temperature range  
-10 ... +60 °C
-  - Input pressure  
1 ... 16 bar



The proportional lubricator adds a precision adjustable quantity of oil to the compressed air stream.

The pressure drop that occurs when air flows through a Venturi nozzle is used to convey oil from the container to the drip cap. From here, the oil drips into the air duct directly behind the proportional valve, where it is atomised. The oil mist component is pro-

portional to the compressed air flow rate.

- Proportional lubricator with precision oil metering
- Reduces wear on drive units subject to high loading
- High flow rate
- Quick and easy oil top-up even during operation (under pressure)

The following oils are recommended for Festo components:  
Viscosity range to ISO 3448, ISO class VG 32  
32 mm<sup>2</sup>/s (= cSt) at 40°C

- Festo special oil OFSW-32 → 21
- ARAL Vitam GF 32
- BP Energol HLP 32
- Esso Nuto H 32
- Mobil DTE 24
- Shell Tellus Oil DO 32

General technical data					
Size	MS4		MS6		
Pneumatic connection 1, 2	G <sup>1</sup> / <sub>8</sub>	G <sup>1</sup> / <sub>4</sub>	G <sup>1</sup> / <sub>4</sub>	G <sup>3</sup> / <sub>8</sub>	G <sup>1</sup> / <sub>2</sub>
Design	Proportional standard mist lubricator				
Type of mounting	Via accessories				
	In-line installation				
Assembly position	Vertical ±5°				
Bowl guard	Plastic bowl guard				
	Metal bowl				
Minimum flow for lubricator operation [l/min]	40		50		
Max. oil capacity [cm <sup>3</sup> ]	30 (with plastic bowl guard) 36 (with metal bowl)		75 (with plastic bowl guard) 80 (with metal bowl)		

-  - Note: This product conforms with the ISO 1179-1 standard and the ISO 228-1 standard.

Standard nominal flow rate q <sub>N</sub> [l/min]					
Size	MS4		MS6		
Pneumatic connection	G <sup>1</sup> / <sub>8</sub>	G <sup>1</sup> / <sub>4</sub>	G <sup>1</sup> / <sub>4</sub>	G <sup>3</sup> / <sub>8</sub>	G <sup>1</sup> / <sub>2</sub>
In main flow direction 1 → 2	1,100	2,200	2,500	5,300	7,200

Operating and environmental conditions		
Size	MS4	MS6
Input pressure [bar]	1 ... 12	1 ... 16
Operating medium	Compressed air	
Ambient temperature [°C]	-10 ... +60	0 ... +60
Temperature of medium [°C]	-10 ... +60	0 ... +60
Storage temperature [°C]	-10 ... +60	-10 ... +60
Corrosion resistance CRC <sup>1)</sup>	2	

1) Corrosion resistance class 2 according to Festo standard 940 070

Components requiring moderate corrosion resistance. Externally visible parts with primarily decorative surface requirements which are in direct contact with a normal industrial environment or media such as coolants or lubricating agents.

# Lubricators MS4/MS6-LOE, MS series

Technical data

FESTO

Weights [g]		
Size	MS4	MS6
Lubricator with plastic bowl guard R	194	600
Lubricator with metal bowl U	354	810

## Materials

Sectional view

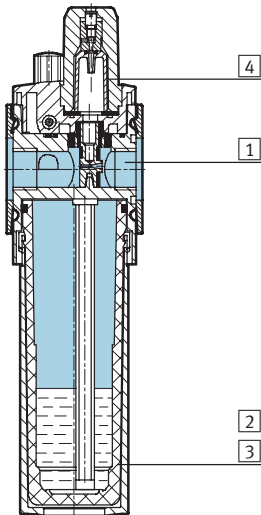

Lubricators		
1	Body	Die-cast aluminium
2	Plastic bowl guard	Polycarbonate/polyamide
3	Metal bowl Viewing window	Aluminium Polyamide
4	Lubricator dome	Polycarbonate
-	Seals	Nitrile rubber

## Standard flow rate $q_n$ as a function of the differential pressure $\Delta p_{1-2}$

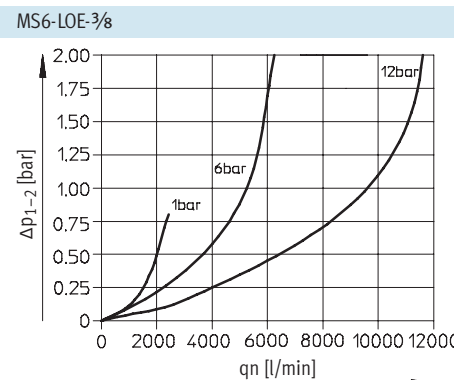
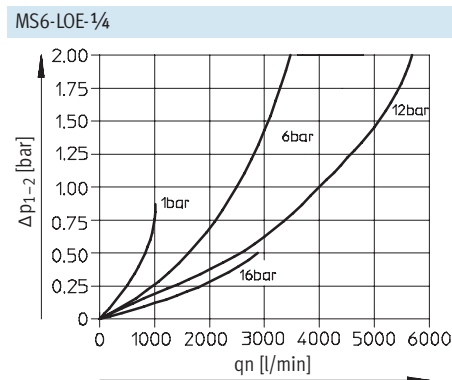
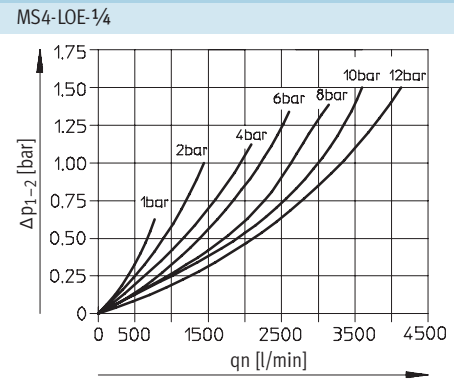
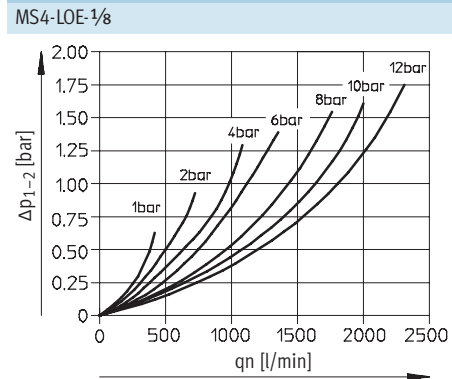

# Lubricators MS4/MS6-LOE, MS series

Technical data

FESTO

## Standard flow rate $q_n$ as a function of the differential pressure $\Delta p_{1-2}$

MS6-LOE- $\frac{1}{2}$

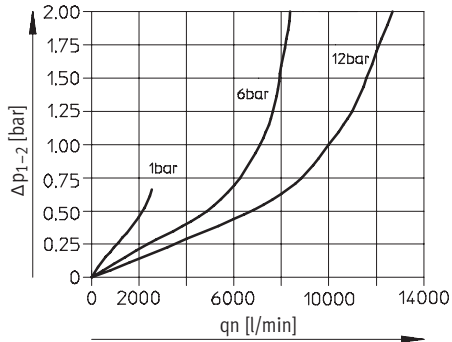

## Dimensions – Standard

Download CAD data → [www.festo.com](http://www.festo.com)

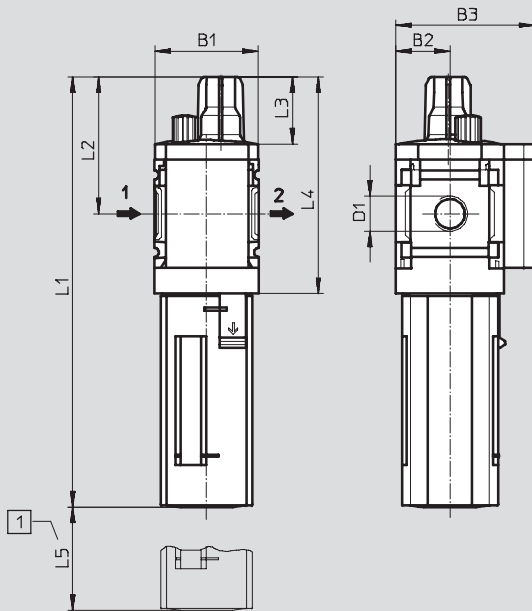

1 Installation dimensions

→ Flow direction

Type	B1	B2	B3	D1	L1		L2	L3	L4	L5
					Plastic	Metal				
MS4-LOE- $\frac{1}{8}$	42	21	54	G $\frac{1}{8}$	166.6	184.9	53	26	84	80
MS4-LOE- $\frac{1}{4}$				G $\frac{1}{4}$						
MS6-LOE- $\frac{1}{4}$	62	31	76	G $\frac{1}{4}$	215.7	222	66	27	111	130
MS6-LOE- $\frac{3}{8}$				G $\frac{3}{8}$						
MS6-LOE- $\frac{1}{2}$				G $\frac{1}{2}$						

– Note: This product conforms with the ISO 1179-1 standard and the ISO 228-1 standard.

## Ordering data

Size	Connection	Plastic bowl guard		Metal bowl	
		Part No.	Type	Part No.	Type
MS4	G $\frac{1}{8}$	529413	MS4-LOE- $\frac{1}{8}$ -R	535791	MS4-LOE- $\frac{1}{8}$ -U
	G $\frac{1}{4}$	529411	MS4-LOE- $\frac{1}{4}$ -R	535790	MS4-LOE- $\frac{1}{4}$ -U
MS6	G $\frac{1}{4}$	529779	MS6-LOE- $\frac{1}{4}$ -R	529781	MS6-LOE- $\frac{1}{4}$ -U
	G $\frac{3}{8}$	529783	MS6-LOE- $\frac{3}{8}$ -R	529785	MS6-LOE- $\frac{3}{8}$ -U
	G $\frac{1}{2}$	529775	MS6-LOE- $\frac{1}{2}$ -R	529777	MS6-LOE- $\frac{1}{2}$ -U

# Lubricators MS4/MS6-LOE, MS series

Ordering data – Modular products

M Mandatory data						O Options	
Module No.	Series	Size	Function	Connection size	Bowl	Type of mounting	Alternative flow direction
527701	MS	4	LOE	1/8, 1/4, 3/8, 1/2, AGA, AGB, AGC, AGD, AGE	R	WP WPM WB WBM	Z
527674		6			U		
<b>Order example</b>							
527701	MS	4	- LOE	- AGB	- R	- WP	- Z

Ordering table							
Grid dimension	[mm]	40	62	Conditions	Code	Enter code	
M	Module No.	527701		527674			
	Series	Standard			MS		MS
	Size	4	6		...		
	Function	Lubricators			-LOE		-LOE
	Connection size	G <sup>1</sup> / <sub>8</sub> thread		-	- <sup>1</sup> / <sub>8</sub>		
		Thread G <sup>1</sup> / <sub>4</sub>		Thread G <sup>1</sup> / <sub>4</sub>	- <sup>1</sup> / <sub>4</sub>		
		-		Thread G <sup>3</sup> / <sub>8</sub>	- <sup>3</sup> / <sub>8</sub>		
		-		Thread G <sup>1</sup> / <sub>2</sub>	- <sup>1</sup> / <sub>2</sub>		
		Connecting plate G <sup>1</sup> / <sub>8</sub>		-	-AGA		
		Connecting plate G <sup>1</sup> / <sub>4</sub>		Connecting plate G <sup>1</sup> / <sub>4</sub>	-AGB		
		Connecting plate G <sup>3</sup> / <sub>8</sub>		Connecting plate G <sup>3</sup> / <sub>8</sub>	-AGC		
		-		Connecting plate G <sup>1</sup> / <sub>2</sub>	-AGD		
	-		Connecting plate G <sup>3</sup> / <sub>4</sub>	-AGE			
	Bowl	Plastic bowl with plastic bowl guard			-R		
		Metal bowl			-U		
O	Type of mounting	Mounting bracket		1	-WP		
		Mounting bracket		1	-WPM		
		Mounting bracket			-WB		
		Mounting bracket		-	-WBM		
	Alternative flow direction	Flow direction from right to left			-Z		

1 WP, WPM Only with connecting plate AGA, AGB, AGC, AGD or AGE.

Transfer order code

	MS		-	LOE	-		-		-		-	
--	----	--	---	-----	---	--	---	--	---	--	---	--

# Lubricators MS12-LOE, MS series

Peripherals overview

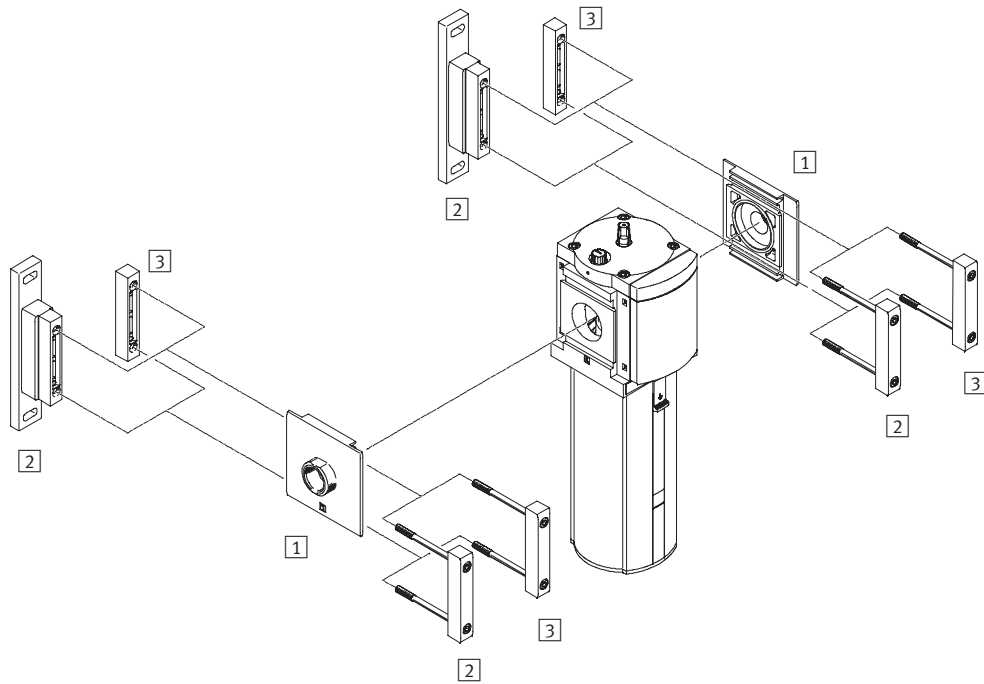

-  - Note  
 Additional accessories:  
 - Module connector for combination with size MS9 → Internet: armv

Mounting attachments and accessories		→ Page/Internet
1	Connecting plate MS12-AG...	ms12-ag
2	Mounting bracket MS12-WP	ms12-wp
3	Module connector MS12-MV	ms12-mv

# Lubricators MS12-LOE, MS series

Type codes

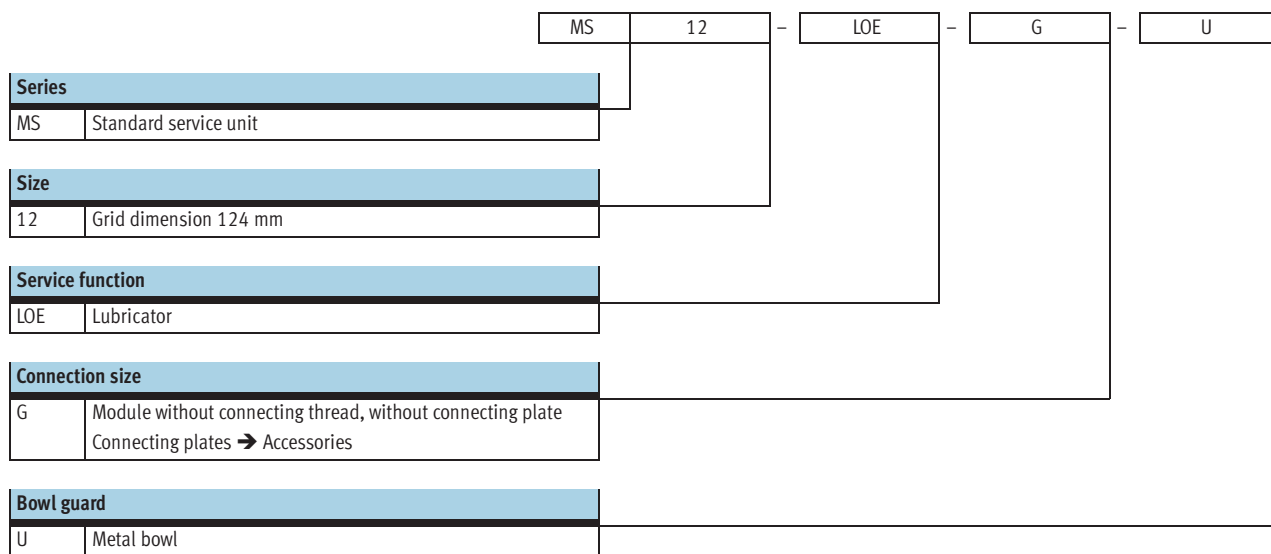

Further variants can be ordered using the modular system → 20

- Connecting plates
- Type of mounting
- Alternative flow direction

# Lubricators MS12-LOE, MS series

Technical data



## Function

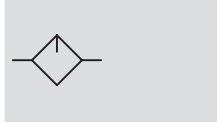

- - Flow rate  
20,000 ... 22,000 l/min

- - Temperature range  
0 ... 60 °C

- - Input pressure  
1 ... 16 bar

- - [www.festo.com](http://www.festo.com)

Wearing parts kits  
→ 19



The proportional lubricator adds a precision adjustable quantity of oil to the compressed air stream. The pressure drop that occurs when air flows through a Venturi nozzle is used to convey oil from the container

to the drip cap. From here, the oil drips into the air duct directly behind the proportional valve, where it is atomised. The oil mist component is proportional to the compressed air flow rate.

- Proportional lubricator with precision oil metering
- Reduces wear on drive units subject to high loading
- High flow rate
- Quick and easy oil top-up even during operation (under pressure)

The following oils are recommended for Festo components:  
Viscosity range to ISO 3448, ISO class VG 32  
32 mm<sup>2</sup>/s (= cSt) at 40°C

- Festo special oil OFSW-32 → 21
- ARAL Vitam GF 32
- BP Energol HLP 32
- Esso Nuto H 32
- Mobil DTE 24
- Shell Tellus Oil DO 32

General technical data				
Pneumatic connection 1, 2 <sup>1)</sup>	G1	G1¼	G1½	G2
Design	Proportional standard mist lubricator			
Type of mounting	Via accessories			
	In-line installation			
Assembly position	Vertical ±5°			
Bowl guard	Metal bowl			
Minimum flow for lubricator operation [l/min]	≤400			
Max. oil capacity [cm <sup>3</sup> ]	1,500			

1) Dependent on connecting plate selected, must be ordered separately as an accessory → Internet: ms12-ag  
- - Note: This product conforms with the ISO 1179-1 standard and the ISO 228-1 standard.

Standard nominal flow rate q <sub>n</sub> N <sup>1)</sup> [l/min]				
Pneumatic connection	G1	G1¼	G1½	G2
In main flow direction 1 → 2	20,000	20,500	21,000	22,000

1) Dependent on connecting plate selected, must be ordered separately as an accessory → Internet: ms12-ag  
Measured at p<sub>1</sub> = 6 bar and Δp = 0.5 bar



# Lubricators MS12-LOE, MS series

Technical data

Operating and environmental conditions		
Input pressure	[bar]	1 ... 16
Operating medium		Compressed air, air quality class 5.7.- to DIN ISO 8573-1
Ambient temperature	[°C]	0 ... +60
Temperature of medium	[°C]	0 ... +60
Storage temperature	[°C]	-10 ... +60
Corrosion resistance	CRC <sup>1)</sup>	2

1) Corrosion resistance class 2 according to Festo standard 940 070  
 Components requiring moderate corrosion resistance. Externally visible parts with primarily decorative surface requirements which are in direct contact with a normal industrial environment or media such as coolants or lubricating agents.

Weights [g]	
Lubricator with metal bowl U	6,500

## Materials

Sectional view

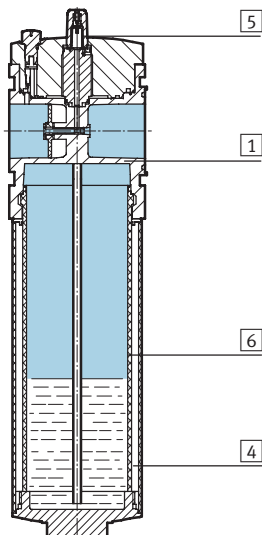

Lubricator		
1	Body	Die-cast aluminium
4	Metal bowl	Aluminium/polyamide
5	Lubricator dome	Polycarbonate
6	Metal bowl sight glass	Polyamide
-	Seals	Nitrile rubber

# Lubricators MS12-LOE, MS series

Technical data

FESTO

## Standard flow rate $q_n$ as a function of the differential pressure $\Delta p_{1-2}$

With connecting plate MS12-AGF

Pneumatic connection G1

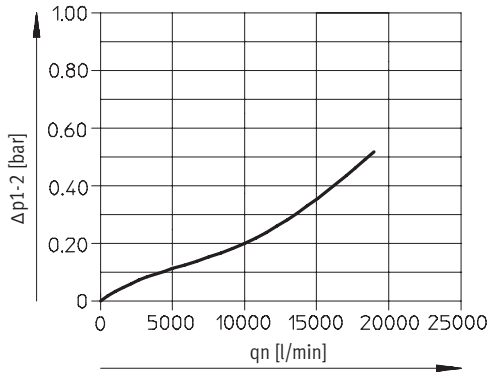

With connecting plate MS12-AGG

Pneumatic connection G1¼

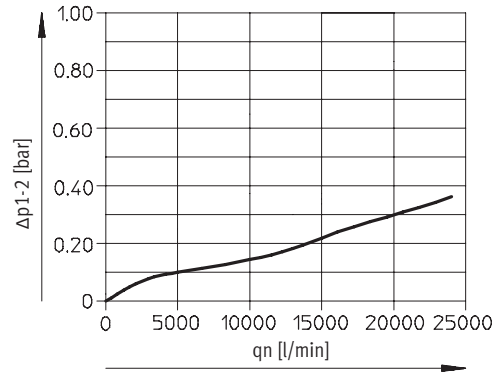

With connecting plate MS12-AGH

Pneumatic connection G1½

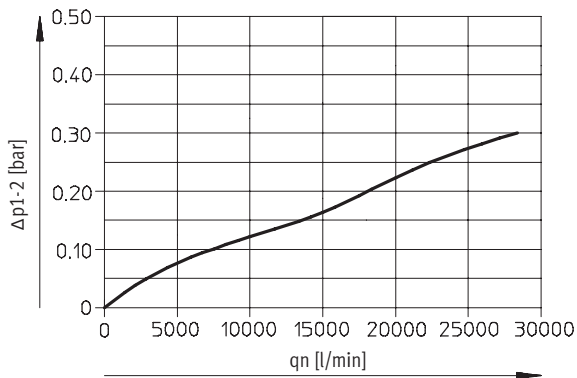

With connecting plate MS12-AGI

Pneumatic connection G2

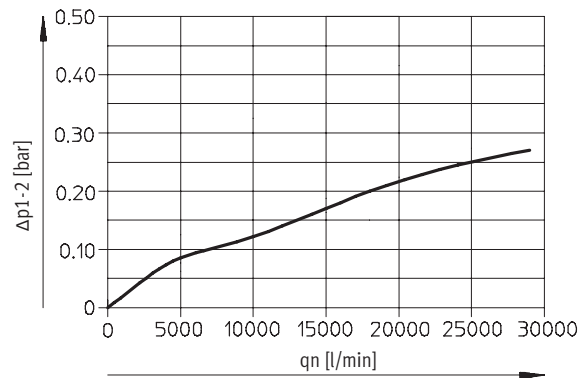

# Lubricators MS12-LOE, MS series

Technical data

## Dimensions – Standard

Download CAD data → [www.festo.com](http://www.festo.com)

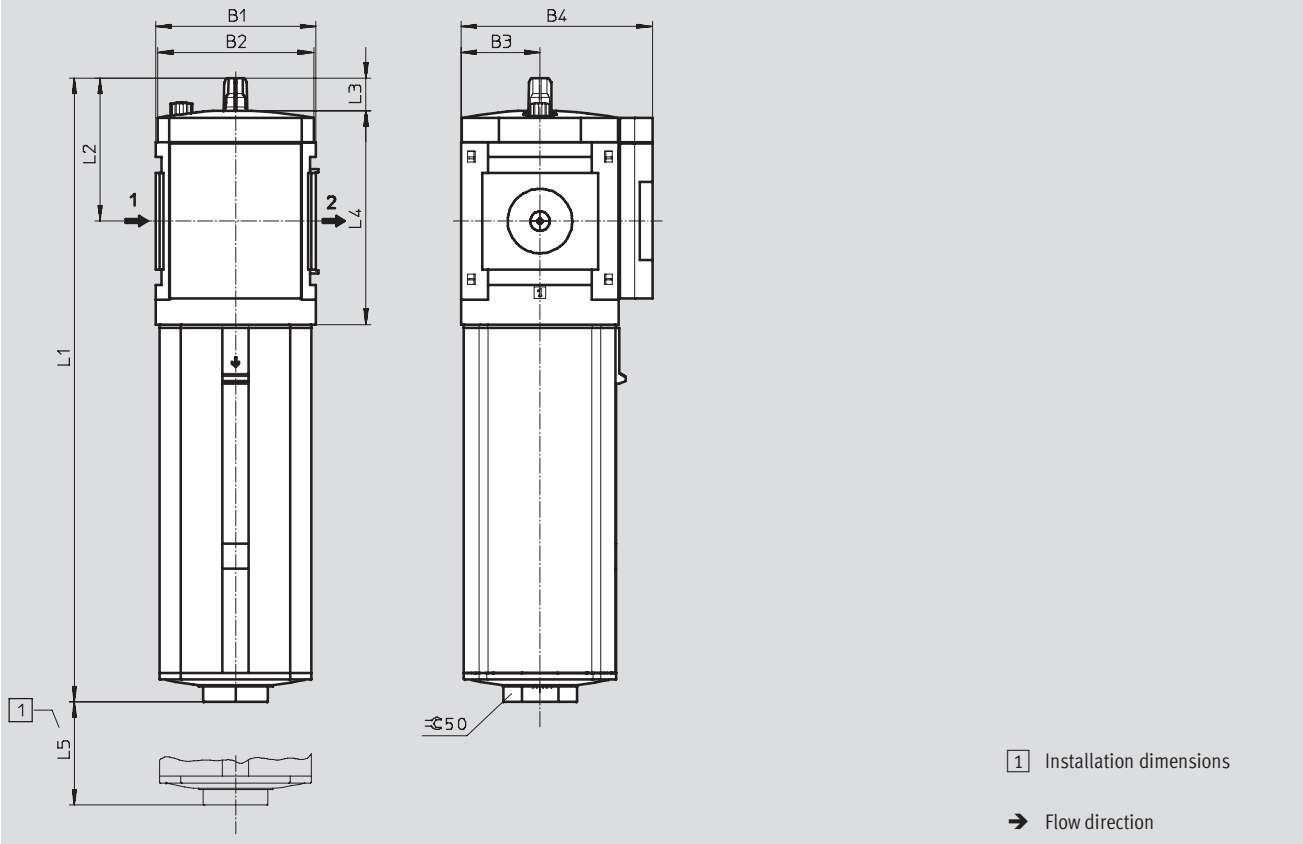

1 Installation dimensions

→ Flow direction

Type	B1	B2	B3	B4	L1	L2	L3	L4	L5
MS12-LOE	124	122	61	148	483	111	25	166	300

## Ordering data

Metal bowl

Size	Connection	Part No.	Type
MS12	G1 ... G2 <sup>1)</sup>	537156	MS12-LOE-G-U

1) Connecting plate must be ordered separately as an accessory → Internet: ms12-ag

· || · Note: This product conforms with the ISO 1179-1 standard and the ISO 228-1 standard.

## Ordering data – Wearing parts kits

Size	Part No.	Type
MS12	673746	MS12-LOE

# Lubricators MS12-LOE, MS series

Ordering data – Modular products

M Mandatory data						O Options	
Module No.	Series	Size	Function	Connection size	Bowl	Type of mounting	Alternative flow direction
535041	MS		LOE	AGF AGG AGH AGI G	U	WP	Z
<b>Order example</b>							
<b>535041</b>	<b>MS</b>	<b>12</b>	<b>- LOE</b>	<b>- AGI</b>	<b>- U</b>	<b>- WP</b>	<b>- Z</b>

Ordering table				Condi- tions	Code	Enter code
Grid dimension	[mm]	124				
M	Module No.	535041				
	Series	Standard			MS	MS
	Size	12			12	12
	Function	Lubricator			-LOE	-LOE
	Connection size	Connecting plate G1			-AGF	
		Connecting plate G1¼			-AGG	
		Connecting plate G1½			-AGH	
		Connecting plate G2			-AGI	
		Module without connecting thread, without connecting plate			-G	
	Bowl	Metal bowl			-U	-U
O	Type of mounting	Mounting bracket		1	-WP	
	Alternative flow direction	Flow direction from right to left			-Z	

1 WP Only with connecting plate AGF, AGG, AGH or AGI.

Transfer order code

535041	MS	12	-	LOE	-		-	U	-		-	
--------	----	----	---	-----	---	--	---	---	---	--	---	--

## Lubricators MS-LOE, MS series

Accessories

**FESTO**

Special oil



Ordering data		
Scope of delivery	Part No.	Type
1 litre	152811	OFSW-32